



## PTI15 Series

Intelligent Indicating  
Transmitter/Switch



**Operating Instructions**



## Table Of Contents

<b>1. General information</b>	<b>4</b>
<b>2. Design and function</b>	<b>5</b>
<b>3. Safety</b>	<b>7</b>
<b>4. Transport, packaging and storage</b>	<b>10</b>
<b>5. Usage, operation</b>	<b>11</b>
<b>6. Faults</b>	<b>21</b>
<b>7. Maintenance and cleaning</b>	<b>24</b>
<b>8. Dismounting, return and disposal</b>	<b>25</b>
<b>9. Specifications</b>	<b>27</b>
<b>10. Accessories and spare parts</b>	<b>34</b>

Declarations of conformity can be found online at [www.noshok.com](http://www.noshok.com).

# 1. General information

- The NOSHOK PTI15 Series Intelligent Indicating Transmitter/Switch described in these operating instructions has been designed and manufactured using state-of-the-art technology. All components are subject to stringent quality and environmental criteria during production. Our quality management systems are certified to ISO 9001:2015.
- These operating instructions contain important information on handling the instrument. Working safely requires that all safety instructions and work instructions are observed.
- Observe the relevant local accident prevention regulations and general safety regulations for the instrument's range of use.
- The operating instructions are part of the product and must be kept in the immediate vicinity of the instrument and readily accessible to skilled personnel at any time.
- Skilled personnel must have carefully read and understood the operating instructions prior to beginning any work.
- The manufacturer's liability is void in the case of any damage caused by using the product contrary to its intended use, non-compliance with these operating instructions, assignment of insufficiently qualified skilled personnel or unauthorized modifications to the instrument.
- The general terms and conditions contained in the sales documentation shall apply.
- Subject to technical modifications.
- Further information:  
[www.noshok.com](http://www.noshok.com)  
T: 440.243.0888  
F: 440.243.3472  
[info@noshok.com](mailto:info@noshok.com)

## 2. Design and function

### 2.1 Scope of delivery

- PTI15 Series Intelligent Indicating Transmitter/Switch
- Operating instructions
- Test report

Cross-check scope of delivery with delivery note.

### 2.2 Overview



- 1 INFO button
- 2 Digital indicator
- 3 Status display, switching outputs
- 4 MENU button
- 5 Confirmation button
- 6 Electrical connection
- 7 Process connection, spanner flats
- 8 Process connection, thread

## 2. Design and function

### 2.1 Display and operating unit

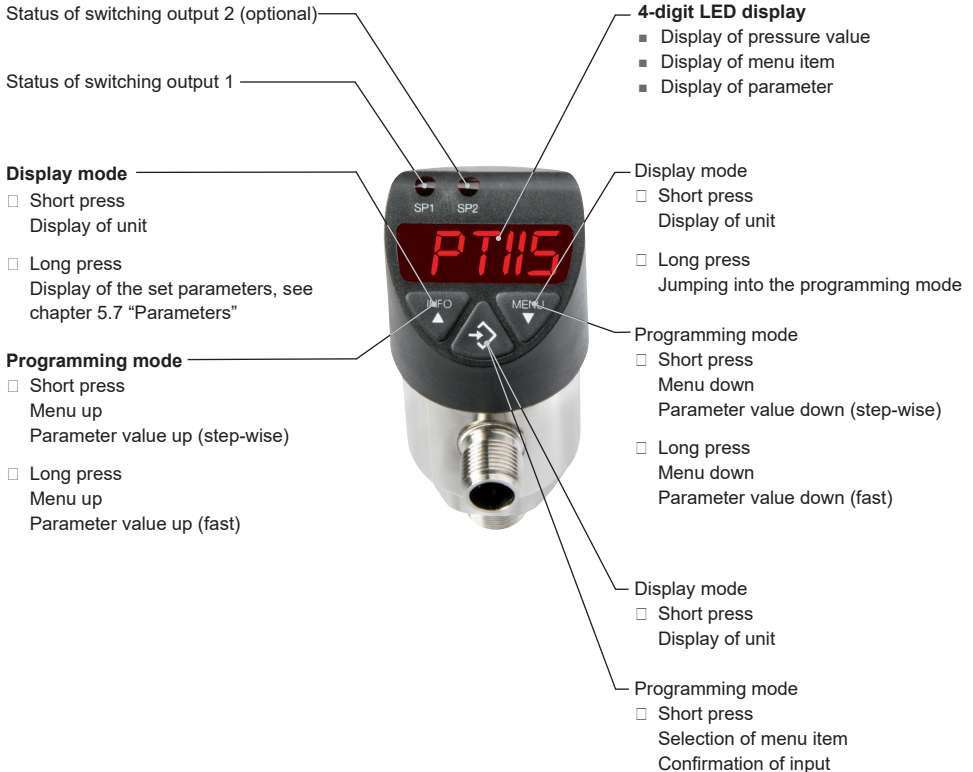

## 3. Safety

### 3.1 Explanation of symbols



**WARNING!**

... indicates a potentially dangerous situation that can result in serious injury or death, if not avoided.



**CAUTION!**

... indicates a potentially dangerous situation that can result in light injuries or damage to property or the environment, if not avoided.



**WARNING!**

... indicates a potentially dangerous situation that can result in burns caused by hot surfaces or liquids, if not avoided.



**Information**

... points out useful tips, recommendations and information for efficient and trouble-free operation.

### 3.2 Intended use

The instrument has been designed and built solely for the intended use described here, and may only be used accordingly. The manufacturer shall not be liable for claims of any type based on operation contrary to the intended use.

#### Intended use

NOSHOK PTI15 Series Intelligent Indicating Transmitter/Switch is used for the switching of circuits as a function of the measured pressure. In addition, the pressure value can be output to appropriate read-out units as a standardized analog signal. The switching conditions can be programmed directly at the pressure transmitter/switch (switch and reset points, etc.). Via the different display elements, switching statuses and pressure values can be read.

This is a class B instrument for emissions and is intended for use in industrial environments. In other environments, e.g. residential or commercial installations, it can interfere with other equipment under certain conditions. In such circumstances the operator is expected to take the appropriate measures.

## 3. Safety

### Application areas

Only use the NOSHOK PTI15 Series pressure transmitter/switch in applications that lie within its technical performance limits (e.g. max. ambient temperature, material compatibility, etc.).

→ For performance limits see chapter 9 "Specifications".

### Technical restrictions

- The overload pressure must never be exceeded, even when failures occur in the end-use application. Loadings above the overload safety can cause measuring errors.
- Pressure surges below the nominal pressure and shorter than 1 ms can cause measuring errors.
- For applications where pressure spikes can occur, the use of a restrictor is recommended. The restrictor narrows the pressure port to 0.3 mm and thus increases the resistance against pressure spikes.
- With media that could block the pressure port (e.g. through particles), a flush instrument version must be used.
- With a high ambient temperature and a high UV irradiation, the pressure transmitter/switch must be installed with additional covering in order to avoid damage to the digital indicator and buttons.
- The medium temperature at the instrument must not exceed 185 °F (85 °C). With hotter media, a cooling element can provide a solution (see chapter 10 "Accessories and spare parts").

### 3.3 Personnel qualification

#### Skilled personnel

Skilled personnel, authorized by the operator, are understood to be personnel who, based on their technical training, knowledge of measurement and control technology and on their experience and knowledge of country-specific regulations, current standards and directives, are capable of carrying out the work described and independently recognizing potential hazards.

Special operating conditions require further appropriate knowledge, e.g. of aggressive media.

## 3. Safety

### 3.4 Use of accessories and spare parts

It is recommended to use original accessories and original spare parts from NOSHOK. Using accessories and spare parts from third parties can lead to damage to the instrument or accidents, due to quality defects or other reasons.

NOSHOK assumes no liability for damage or accidents caused by a malfunction or unsuitability of accessories and spare parts which do not originate from NOSHOK (e.g. non-compliance with the IP ingress protection of connectors). No warranty claims can be made which arise due to a malfunction or unsuitability of any accessory or spare part from a third party.

### 3.5 Labeling, safety marks

#### Product label

If the serial number becomes illegible (e.g. due to mechanical damage or overpainting), traceability will no longer be possible.

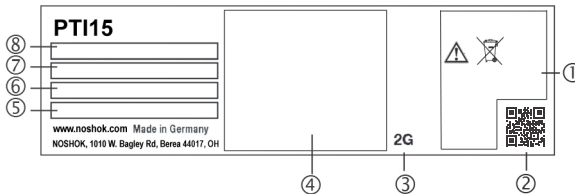

- |  |                            |
|--|----------------------------|
| ① Approvals and conformities           | ⑤ Serial number            |
| ② QR code to serial number application | ⑥ Article number           |
| ③ Coded date of manufacture            | ⑦ Measuring range          |
| ④ Pin assignment and specifications    | ⑧ IO-Link version (option) |

#### Symbols



Before mounting and commissioning the instrument, ensure you read the operating instructions!

## 4. Transport, packaging and storage



For the protection of the diaphragm, the flush design is delivered with a special protection cap.

- In order to avoid damage at the diaphragm and/or the process connection thread, remove the protection cap by hand only just before installation.
- Keep the protection cap for subsequent storage or transport.
- Fit the protection cap before dismounting and transporting the instrument.

### 4.1 Transport

Check the NOSHOK PTI15 Series pressure transmitter/switch for any damage that may have been caused by transport. With flush design, additionally check the diaphragm for any optical damage. Obvious damage must be reported immediately.

### 4.2 Packaging and storage

Do not remove packaging until just before mounting.

Keep the packaging as it will provide optimum protection during transport (e.g. change in installation site, sending for repair).

#### Permissible conditions at the place of storage:

- Storage temperature: -4 °F - 158 °F (-20 °C - 70 °C)
- Humidity: 45 - 75 % relative humidity (no condensation)

In order to protect the diaphragm, mount the protection cap before storing the instrument.

## 5. Usage, operation

### 5.1 Check the instrument

Prior to usage, the PTI15 Series pressure transmitter/switch must be subjected to a visual inspection.

- Leaking fluid is indicative of damage.
- Only use the pressure transmitter/switch if it is in perfect condition with respect to safety.
- Check the diaphragm for any visible damage, since this is a safety-relevant component.

### 5.2 Requirements for mounting point

The mounting point must meet the following conditions:

- Protected from weather influences.
- With a high ambient temperature and a high UV irradiation, the pressure transmitter/switch must be installed with additional covering in order to avoid damage to the digital indicator and buttons.
- Sealing faces are clean and undamaged.
- Sufficient space for a safe electrical installation.
- Permissible ambient and medium temperatures remain within the performance limits. Consider possible restrictions on the ambient temperature range caused by mating connector used.
  - For performance limits see chapter 9 "Specifications"

## 5. Usage, operation

### 5.3 Mechanical mounting



The max. torque depends on the mounting point (e.g. material and shape). If you have any questions, please contact our factory.  
→ For contact details see chapter 1 “General information” or the back page of the operating instructions.

1. Seal the sealing face (→ see “Sealing variants”).
2. At the mounting point, screw the pressure transmitter/switch in hand-tight.
3. Tighten with a torque spanner using the spanner flats.

#### Sealing variants

##### Parallel threads

Seal the sealing face ① with flat gasket, lens-type sealing ring or NOSHOK profile sealing.

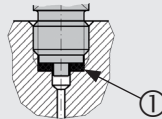

per EN 837

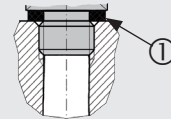

per DIN 3852-E

##### Tapered threads

Wrap threads with sealing material (e.g. PTFE tape).

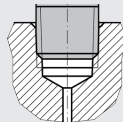

NPT, R and PT

## 5. Usage, operation

### 5.4 Electrical mounting

#### 5.4.1 Requirements for voltage supply

→ For power supply see product label

The power supply for the NOSHOK PTI15 Series pressure transmitter/switch must be made via an energy-limited electrical circuit in accordance with section 9.4 of UL/EN/IEC 61010-1, or an LPS per UL/EN/IEC 60950-1 / CSA C22.2 no. 60950-1, or class 2 in accordance with UL1310/UL1585 (NEC or CEC). The voltage supply must be suitable for operation above 2,000 m should the pressure transmitter/switch be used at this altitude.

#### 5.4.2 Requirements for electrical connection

- Ingress protection of the mating connector corresponds to the ingress protection of the PTI15 Series pressure transmitter/switch.
- Cable diameter matches the cable bushing of the mating connector.
- Cable gland and seals of the mating connector are correctly seated.
- No humidity can ingress at the cable end.

#### 5.4.3 Requirement for shielding and grounding

The PTI15 Series pressure transmitter/switch must be shielded and grounded in accordance with the grounding concept of the application.

#### 5.4.4 Pin assignment

→ For pin assignments, see product label or connection diagram

Circular connector M12 x 1 (4-pin)		
	U+	1
	U-	3
	S+	2
	SP1/C 1)	4
	SP2	2

Circular connector M12 x 1 (5-pin)		
	U+	1
	U-	3
	S+	5
	SP1/C	4
	SP2	2

1) Depending on the configuration of the output signals

#### Legend:

U+ Positive power supply terminal  
U- Negative power supply terminal  
S+ Analogue output

SP1 Switching output 1  
SP2 Switching output 2  
C Communication with IO-Link

## 5. Usage, operation

### 5.5 Zero point setting

Check the indicated zero point on the digital indicator during usage. Should a zero point offset be displayed as a result of installation, this can be reset in programming mode with the OSET parameter. Carry out zero point setting for gauge and vacuum pressure measuring ranges in a depressurized state.



Carry out zero point setting of absolute pressure measuring ranges at 0 bar absolute (vacuum). Since appropriate references are required for this, we recommend that this is only carried out by the manufacturer.

### 5.6 Operating modes

Mode	Description
System start	Digital indicator is fully activated for 1 sec. When the NOSHOK PTI15 Series pressure transmitter/switch is powered up within the range of the hysteresis, the output switch is set to "not active" by default.
Programming mode (setting the parameters)	<b>Activating the programming mode</b> Keep the "MENU" button pressed for approx. 5 sec. If the password is set to $\neq$ 0000, a password will be requested. If authentication is successful, then it enters the programming mode, otherwise it reverts to display mode.  <b>Timeout</b> If, during the setting of a parameter, no button is pressed for 60 s, the instrument returns to the display mode with the value unchanged.
Display mode (normal operation, display of pressure value)	<b>Returning to the display mode</b> Simultaneous pressing of "INFO" and "MENU"

## 5. Usage, operation

### 5.7 Overview of parameters

Menu item	Description	Parameter	Factory setting
SP1/SP2	Hysteresis function: Switch point (switching output 1 / 2)	0.25 ... 100 % of measuring range	Nominal pressure
FH1/FH2	Window function: Window high (switching output 1 / 2)	0.25 ... 100 % of measuring range	Nominal pressure
RP1/RP2	Hysteresis function: Reset point, switching output (1 or 2)	0 ... (switch point - 0.25 % of measuring range)	Nominal pressure - 10 %
FL1/FL2	Window function: Window low switching output (1 or 2)	0 ... (window high - 0.25 % of measuring range)	Nominal pressure - 10 %
EF	Extended programming functions		
RES	Reset the set parameters to the factory settings	Yes / No	
DS1/DS2	Switching delay time, which must occur without interruption before any electrical signal change occurs (SP1 or SP2)	0.00 ... 65.00 s	0.00 s
DR1/DR2	Reset delay time, which must occur without interruption before any electrical signal change occurs (RP1 or RP2)	0.00 ... 65.00 s	0.00 s
OU1 / OU2	Switching function (switching output 1 / 2)	HNO = hysteresis function, normally open HNC = hysteresis function, normally closed FNO = window function, normally open FNC = window function, normally closed	HNO
OU3	Output signal switching	I = 4 ... 20 mA U = DC 0 ... 10 V	I
POL1/POL2	Switching logic (switching output 1 / 2)	PNP, NPN	PNP
ALOW	Measuring range scaling/turndown (analog value, start value)	corresponding to analog output	Start of measuring range
AHGH	Measuring range scaling/turndown (analog value, end value)	corresponding to analog output	End of measuring range
AVGD	Damping (digital indicator)	0.00 ... 65.00 s	0.20 s

## 5. Usage, operation

Menu item	Description	Parameter	Factory setting
AVG1/AVG2	Damping (switching output 1 / 2)	0.00 ... 65.00 s	0.00 s
AVG3	Damping (analog signal)	0.00 ... 65.00 s	0.00 s
UNIT	Unit switching	BAR, mBAR, MPA, KPA, PSI, KGcm (kg/cm <sup>2</sup> ), %	Order-related
OSET	Adjust zero point / Perform "Autozero" (max. 3 % of span)	Yes / No	
DISM	Display value in display mode	ACT = current system pressure LOW, HIGH = Min/Max system pressure OFF = display off SP1/FH1 = set switching value RP1/FL1 = set switching value SP2/FH2 = set switching value RP2/FL2 = set switching value	ACT
DISU	Refresh rate (digital indicator)	1, 2, 5, 10 updates/second	5
DISR	Rotate the indication by 180° (digital indicator)	Yes / No	
DRES	Resolution (digital indicator)	OPT = optimised (stable measurement value on display with rounding factors for the last digit, optimised to the measuring range)  FULL = maximum (finest resolution, if required for a stable measurement value on display, a damping must be set for the digital indicator)	OPT
RHL	Clear memory (Min/Max system pressure)	Yes / No	
PAS	Password entry	0000 = no password Password input digit by digit	0000
TAG	Measuring instrument name (TAG)	32 selectable characters (A-Z, 0 ... 9; - ,SPACE) (2 spaces in sequence terminate the input and lead to the deletion of this and the underlying characters)	without

# 5. Usage, operation

## 5.8 Menu tree

Certain menu items (light grey) are only displayed if the pressure transmitter/switch features the respective option.

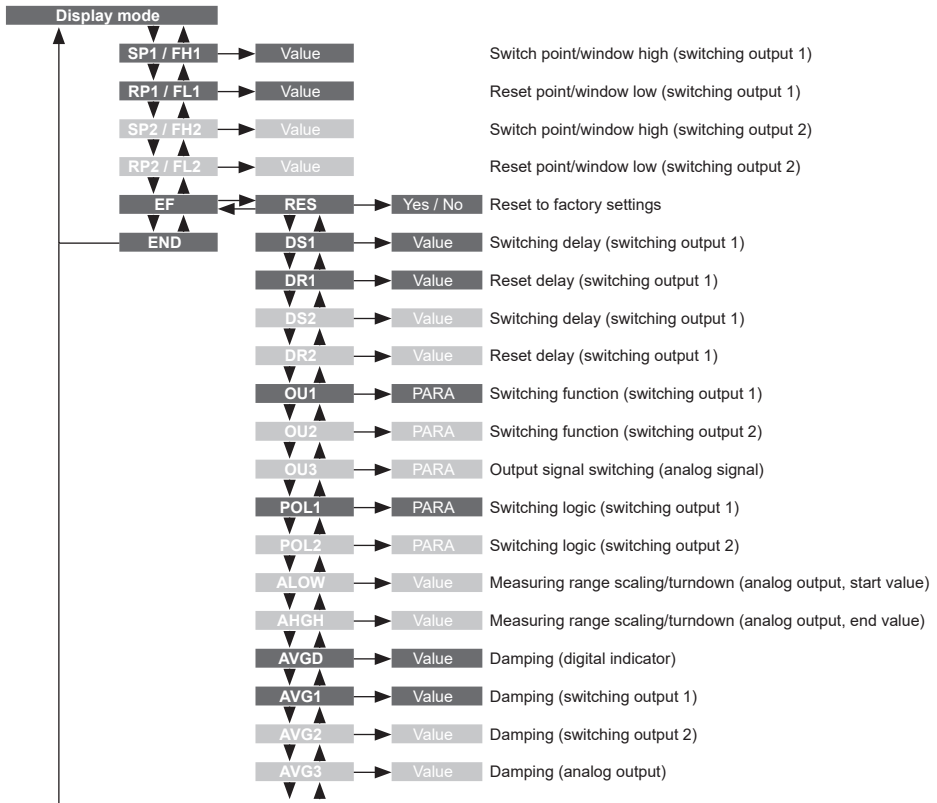

## 5. Usage, operation

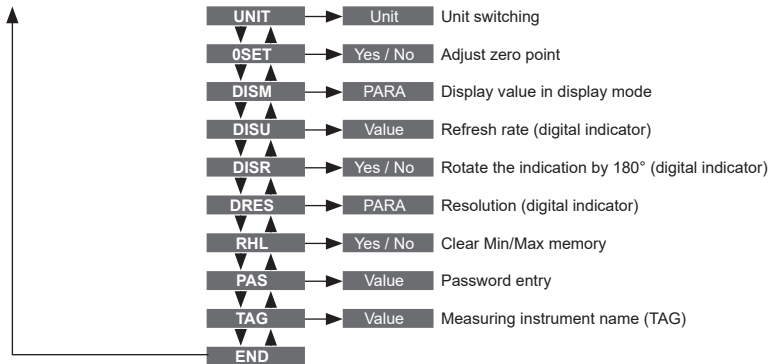

## 5. Usage, operation

### 5.9 Switching functions

#### Hysteresis function

If the system pressure fluctuates around the set point, the hysteresis keeps the switching status of the outputs stable. With increasing system pressure, the output switches when reaching the switch point (SP).

- Contact normally open (HNO): Active
- Contact normally closed (HNC): Inactive

With system pressure falling again, the output will not switch back before the reset point (RP) is reached.

- Contact normally open (HNO): Inactive
- Contact normally closed (HNC): Active

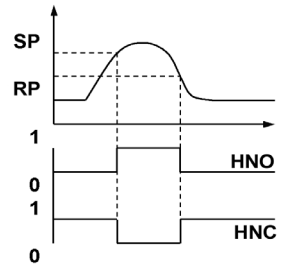

Fig.: Hysteresis function

#### Window function

The window function allows for the control of a defined range.

When the system pressure is between window high (FH) and window low (FL), the output switches on.

- Contact normally open (FNO): Active
- Contact normally closed (FNC): Inactive

When the system pressure is outside window high (FH) and window low (FL), the output does not switch on.

- Contact normally open (FNO): Inactive
- Contact normally closed (FNC): Active

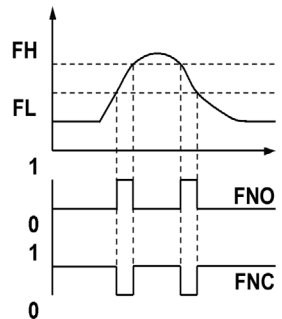

Fig.: Window function

## 5. Usage, operation

### Delay times (0 - 65 s)

This makes it possible to filter out unwanted pressure peaks of a short duration or a high frequency. The pressure must be present for at least a certain pre-set time for the output to switch on. The output does not immediately change its status when it reaches the switching event (SP), but rather only after the pre-set delay time (DS).

If the switching event is no longer present after the delay time, the switching output does not change. The output only switches back when the system pressure has fallen down to the reset point (PR) and stays at or below the reset point (RP) for at least the pre-set delay time (DR).

If the switching event is no longer present after the delay time, the switching output does not change.

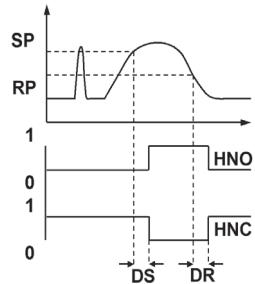
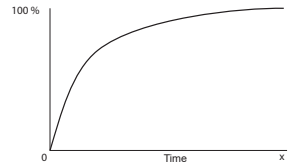

Fig.: Delay times

### 5.10 Damping function

The time constant "x" specifies the time duration which the digital indicator, the switching output or the analog signal requires to approach the end value with a deviation of  $\pm 1\%$  following a change in measured value. After a duration of 2 times "x", the output value has reached 100% with a deviation of  $\pm 0.01\%$  of the prevailing pressure.



### 5.11 Measuring range scaling (turndown)

For versions with analog signals, start of measuring range and end of measuring range can be set within the permissible measuring range (turndown of 5:1 not to be exceeded).

### 5.12 Description of the IO-Link functionality (optional)

IO-Link is a point-to-point connection for the communication of the PTI15 Series Intelligent Indicating Transmitter/Switch with an IO-Link master.

IO-Link specification: Version 1.1

A detailed description of the IO-Link functionality and the device description file (IODD) can be found online on the product details page of the PTI15 Series Intelligent Indicating Transmitter/Switch at [www.noshok.com](http://www.noshok.com).

## 6. Faults



### CAUTION!

#### Physical injuries and damage to property and the environment

If faults cannot be eliminated by means of the listed measures, the NOSHOK PTI15 Series pressure transmitter/switch must be taken out of operation immediately.

- Ensure that pressure or signal is no longer present and protect against accidental commissioning. If measuring range scaling is set, despite an analog value of 4 mA or 0 V, pressure can still be present.
- Contact the manufacturer.
- If a return is needed, please follow the instructions given in chapter 8.2 "Return".



### WARNING!

#### Physical injuries and damage to property and the environment caused by hazardous media

Upon contact with hazardous media (e.g. oxygen, acetylene, flammable or toxic substances), harmful media (e.g. corrosive, toxic, carcinogenic, radioactive), and also with refrigeration plants and compressors, there is a danger of physical injuries and damage to property and the environment.

- Should a failure occur, aggressive media with extremely high temperature and under high pressure or vacuum may be present at the instrument.
- For these media, in addition to all standard regulations, the appropriate existing codes or regulations must also be followed.
- Wear the requisite protective equipment (see chapter 3.4 "Personal protective equipment").



For contact details see chapter 1 "General information" or the back page of the operating instructions.

## 6. Faults

In the event of any faults, first check whether the pressure transmitter/switch is mounted correctly, mechanically and electrically.

Fault	Possible cause	Measure
No output signal	Cable break	Check the continuity
No output signal	No/wrong power supply	Rectify the power supply
No/wrong output signal	Wiring error or switching of switching logic/analog signal	Observe the pin assignment
		Check the output configuration
Constant output signal upon change in pressure	Mechanical overload caused by overpressure	Replace instrument; if it fails repeatedly, contact the manufacturer
Deviating zero point signal	Overpressure limit exceeded	Observe the permissible overpressure limit
Signal span too small	Mechanical overload caused by overpressure	Replace instrument; if it fails repeatedly, contact the manufacturer
Signal span too small	Power supply too high/low	Rectify the power supply
Signal span drops	Moisture has entered	Fit the cable correctly
Signal span drops/too small	Diaphragm damaged, e.g. due to impacts, abrasive/aggressive medium; corrosion at diaphragm/process connection	Contact manufacturer and replace instrument

### Warnings and errors

Via the digital indicator, the instrument's internal warnings and errors are output. The instrument continues to measure, even when a warning exists. The output signal and the switching outputs are still output.

The following table shows the codes and their meaning.

Warning	Description
ATT1	On changing the switch point, the reset point of the instrument is automatically reduced to the smallest hysteresis of 0.25 %.
ATT2	Zero point adjustment error, current pressure is outside the limits
ATT3	Password entered for menu access is incorrect
ATT4	Unit cannot be displayed on digital indicator, previous unit is used

## 6. Faults

Warning	Description
ATT5	Maximum turndown exceeded
ILOC	Menu locked over IO-Link
OL	Overpressure, measuring range exceeded > approx. 3.125 % (display flashing)
PAS	Prompt for password input
UL	Underpressure, below measuring range < approx. 3.125 % (display flashing)

Error	Description
ERR	<p>Internal error (restarting the instrument or resetting to factory settings can provide a solution)</p> <p>The analog output controls the alarm signal <math>\leq 3.6 \text{ mA}</math> (4 ... 20 mA output signal) or <math>\geq 11 \text{ V}</math> (0 ... 10 V output signal) in accordance with NAMUR43</p> <p>The switching outputs keep the current switching state (output open or closed)</p>
ERR1	<p>Instrument temperature exceeded/too low or power supply too low</p> <p>The analog output is output. There are limitations with respect to accuracy (temperature influence) and maximum analog value (power supply too low)</p> <p>The switching outputs keep the current switching state (output open or closed)</p>
ERR2	<p>Sensor defect detected, check whether high overload pressure is present (can be detected as sensor defect), if necessary, restart instrument or exchange of instrument is needed</p> <p>The analog output controls the alarm signal <math>\leq 3.6 \text{ mA}</math> (4 ... 20 mA output signal) or <math>\geq 11 \text{ V}</math> (0 ... 10 V output signal) in accordance with NAMUR43</p> <p>The switching outputs keep the current switching state (output open or closed)</p>
SC	<p>Short circuit detected at switching output 1 or 2</p> <p>The switching output affected is inactive so long as the short circuit is present</p>

Acknowledge warnings and errors with confirmation button

## 7. Maintenance and cleaning

### 7.1 Maintenance

The NOSHOK PTI15 Series pressure transmitter/switch is maintenance-free.  
Repairs must only be carried out by the manufacturer.

### 7.2 Cleaning



#### **CAUTION!**

#### **Unsuitable cleaning agents**

Cleaning with unsuitable cleaning agents may damage the instrument and the product label.

- Do not use any aggressive cleaning agents.
- Do not use any hard or pointed objects.
- Do not use any abrasive cloths or sponges.

#### **Suitable cleaning agents**

- Water
- Conventional dishwashing detergent

#### **Cleaning the instrument**

Wipe the instrument surface using a soft, damp cloth.

## 8. Dismounting, return and disposal

### 8.1 Dismounting



#### **WARNING!**

#### **Physical injuries and damage to property and the environment caused by hazardous media**

Upon contact with hazardous media (e.g. oxygen, acetylene, flammable or toxic substances), harmful media (e.g. corrosive, toxic, carcinogenic, radioactive), and also with refrigeration plants and compressors, there is a danger of physical injuries and damage to property and the environment.

- Should a failure occur, aggressive media with extremely high temperature and under high pressure or vacuum may be present at the instrument.
- Wear the requisite protective equipment.



#### **WARNING!**

#### **Risk of burns**

During dismounting there is a risk of dangerously hot media escaping.

The pressure transmitter/switch may have heated up severely due to hot media.

- Let the instrument cool down sufficiently before dismounting it.
- Wear the required protective equipment.

### **Dismounting the instrument**

1. Depressurize and de-energize the pressure transmitter/switch.
2. Disconnect the electrical connection.
3. Unscrew the pressure transmitter/switch with a spanner using the spanner flats.

## 8. Dismounting, return

### 8.2 Return

#### **Strictly observe the following when shipping the instrument:**

All instruments delivered to NOSHOK must be free from any kind of hazardous substances (acids, bases, solutions, etc.) and must therefore be cleaned before being returned.



#### **WARNING!**

#### **Physical injuries and damage to property and the environment through residual media**

Residual media in the dismantled instrument can result in a risk to persons, the environment and equipment.

- With hazardous substances, attach the material safety data sheet for the corresponding medium.
- Clean the instrument, see chapter 7.2 “Cleaning”.

When returning the instrument, use the original packaging or a suitable transport packaging.



The RMA Request Form can be found under the heading ‘Contact Us’ at [www.noshok.com](http://www.noshok.com).

### 8.3 Disposal

Incorrect disposal can put the environment at risk.

Dispose of instrument components and packaging materials in an environmentally compatible way and in accordance with the country-specific waste disposal regulations.

## 9. Specifications

Specifications		
<b>Measuring range</b>		
Measuring range	see product label	
Overload safety	The overload safety is based on the sensor element used. Depending on the selected process connection and sealing, restrictions in overload safety can result. $\leq 600$ bar ( $< 8,000$ psi): 2 times $> 1,000$ bar ( $\geq 8,000$ psi): 1.5 times	
Increased overload safety (option)	With increased overload safety there are deviations in temperature error, signal noise and long-term stability.	
Vacuum-tight	Yes	
<b>Digital indicator</b>		
Model	14-segment LED, red, 4-digit, 9 mm (0.35 in) character size Display can be turned electronically by 180°	
<b>Output signal</b>		
Output signal	see product label	
Load	4 ... 20 mA	$\leq 500 \Omega$
	DC 0 ... 10 V	$>$ max. output voltage / 1 mA
IO-Link (option)	Version 1.1	
Zero point setting	max. 3 % of span	
Damping of analog output/switching outputs	configurable from 0 ms ... 65 s	
Switch-on time	1 s	
Switching thresholds	Switch point 1 and switch point 2 are individually adjustable	
Switching functions	Normally open, normally closed, window, hysteresis (freely adjustable)	
Switching voltage	Power supply - 1 V	
Switching current	max. 250 mA	

## 9. Specifications

Specifications		
Settling time/response time	Analog signal: $\leq 5$ ms Switching output: $\leq 5$ ms	
Service life	100 million switching cycles	
Voltage supply		
Power supply	DC 15 ... 35 V  The power supply for the pressure transmitter/switch must be made via an energy-limited electrical circuit in accordance with section 9.3 of UL/EN/IEC 61010-1 or an LPS to UL/EN/IEC 60950-1 or class 2 in accordance with UL 1310/UL1585 (NEC or CEC). The voltage supply must be suitable for operation above 2,000 m should the pressure transmitter/switch be used at this altitude.	
Current consumption	max. 45 mA for versions without 4 ... 20 mA output signal max. 70 mA for versions with 4 ... 20 mA output signal	
Total current consumption	max. 600 mA including switching current	
Accuracy specifications		
Accuracy, analog signal	$\leq \pm 0.5$ % of span  Including non-linearity, hysteresis, zero offset and end value deviation (corresponds to measured error per IEC 61298-2).	
Non-repeatability, analog signal	$\leq 0.1$ % of span (IEC 61298-2)	
Long-term drift, analog signal	$\leq \pm 0.1$ % of span (IEC 61298-2) $\leq \pm 0.2$ % of span (IEC 61298-2) for measuring ranges $\leq 0.6$ bar (10 psi), flush process connection, increased overload safety	
Turndown, analog signal	The analog output signal is freely scalable within the range of 5:1 When setting turndown, there is a proportional increase in the measuring deviation and temperature error.	
Accuracy, switching output	$\leq \pm 0.5$ % of span	
Temperature error in rated temperature range	maximum: $\leq \pm 1.5$ % of span maximum: $\leq \pm 2.5$ % of span for increased overload safety and flush versions	
Temperature coefficients in rated temperature range	Mean TC zero point	$\leq \pm 0.16$ % of span/10 K
	Mean TC span	$\leq \pm 0.16$ % of span/10 K

## 9. Specifications

### Specifications

#### Reference conditions (per IEC 61298-1)

Ambient temperature	15 ... 25 °C (59 ... 77 °F)
Atmospheric pressure	860 ... 1,060 mbar (12.5 ... 15.4 psi)
Humidity	45 ... 75 % r. h.
Power supply	DC 24 V
Mounting position	Calibrated in vertical mounting position with process connection facing downwards.

#### Operating conditions

Permissible temperature ranges	Medium: -20 ... +85 °C (-4 ... +185 °F)
	Ambient: -20 ... +80 °C (-4 ... +176 °F)
	Storage: -20 ... +70 °C (-4 ... +158 °F)
	Nominal temperature: 0 ... 80 °C (32 ... 176 °F)
Vibration resistance	20 g, 10 ... 2,000 Hz (IEC 60068-2-6, under resonance)
Shock resistance	50 g, 6 ms (IEC 60068-2-27, mechanical)
Service life, mechanics	100 million load cycles (10 million load cycles for measuring ranges > 600 bar/7,500 psi)
Ingress protection	IP65 and IP67  The stated ingress protection (per IEC 60529) only applies when plugged in using mating connectors that have the appropriate ingress protection.
Mounting position	as required
Pollution degree	max. 3
Humidity	≤ 45 ... 75 % r. h.
UV irradiation	With a high ambient temperature and a high UV irradiation, the pressure transmitter/switch must be installed with additional covering in order to avoid damage to the digital indicator and buttons.

## 9. Specifications

Specifications		
<b>Electrical connection</b>		
Plug connection	Circular connector M12 x 1 (4- or 5-pin)	
Short-circuit resistance	S+ / SP1 / SP2 vs. U-	
Reverse polarity protection	U <sub>+</sub> vs. U-	
Insulation voltage	DC 500 V	
Overvoltage protection	DC 40 V	
Pin assignment	see product label	
<b>Materials</b>		
Wetted parts	< 10 bar (150 psi): 316L ≥ 10 bar (150 psi): 316L, PH grade steel	
Non-wetted parts	Case	304
	Keyboard	TPE-E
	Display window	PC
	Display head	PC+ABS blend
	Pressure transmission medium	Synthetic oil for all gauge pressure measuring ranges < 10 bar (150 psi) all absolute pressure measuring ranges and flush versions (< 16 bar (250 psi) with increased overload safety).

## 9. Specifications

### Options for specific media

Oil and grease free	Residual hydrocarbon: < 1,000 mg/m <sup>2</sup>
Oxygen, oil and grease free	<ul style="list-style-type: none"> <li>■ Residual hydrocarbon: &lt; 200 mg/m<sup>2</sup></li> <li>■ Packaging: Protection cap on the process connection</li> <li>■ Max. permissible temperature -20 ... +60 °C (-4 ... +140 °F)</li> <li>■ Not available for flush process connections</li> <li>■ Available measuring ranges: 0 ... 10 to 0 ... 1,000 bar (0 ... 150 to 0 ... 7,500 psi) -1 ... 9 to -1 ... 24 bar (-14.5 ... 160 to -14.5 ... 300 psi)</li> <li>■ Factory supplied without sealing</li> <li>■ Available process connections, see "Process connections"</li> </ul>

### Process connections

Standard	Thread size	Overload limit	Sealing
DIN 3852-E	G ¼ A	1,000 bar (14,500 psi)	NBR (options: Without, FPM/FKM)
	G ½ A	1,000 bar (14,500 psi)	NBR (options: Without, FPM/FKM)
EN 837	G ⅝ B	400 bar (5,800 psi)	without (options: Copper, stainless steel)
	G ¾ B <sup>1)</sup>	1,000 bar (14,500 psi)	without (options: Copper, stainless steel)
	G ¾ female <sup>1)</sup>	1,000 bar (14,500 psi)	-
	G ½ B <sup>1)</sup>	1,000 bar (14,500 psi)	without (options: Copper, stainless steel)
ANSI/ASME B1.20.1	¼ NPT <sup>1)</sup>	1,000 bar (14,500 psi)	-
	½ NPT <sup>1)</sup>	1,000 bar (14,500 psi)	-
ISO 7	R ¼ <sup>1)</sup>	1,000 bar (14,500 psi)	-
KS	PT ¼ <sup>1)</sup>	1,000 bar (14,500 psi)	-
-	G ¾ female (Ermeto compatible)	1,000 bar (14,500 psi)	-
	G ½ B flush	1,000 bar (14,500 psi)	NBR (option: FPM/FKM)

1) suitable for oxygen, oil and grease free.

## 9. Specifications

Dimensions in mm (inch)

PTI15 Series pressure transmitter/switch with circular connector M12 x 1 (4-pin and 5-pin)

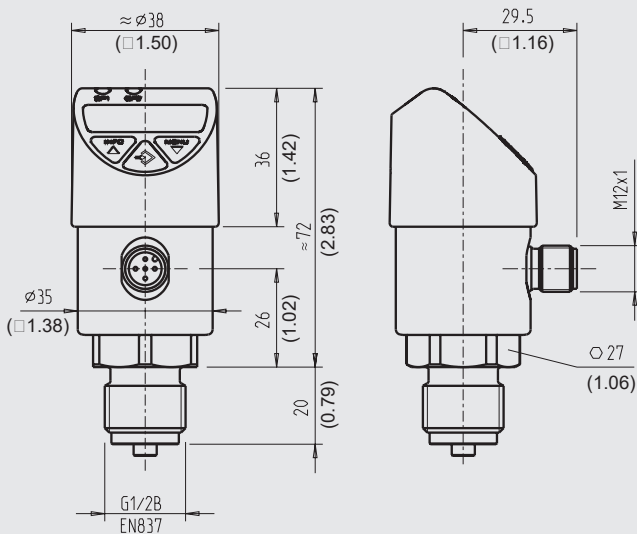

Weight: approx. 220 g (7.76 oz)

## 9. Specifications

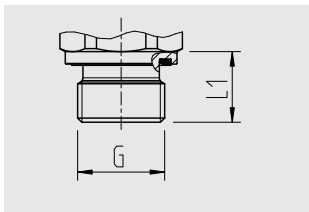

G	L1
G ¼ A DIN 3852-E	14 (0.55)
G ½ A DIN 3852-E	17 (0.67)

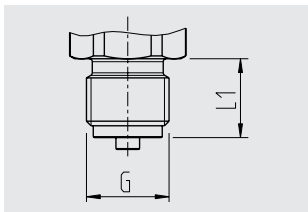

G	L1
G ¼ B EN 837	13 (0.51)
G ½ B EN 837	20 (0.79)

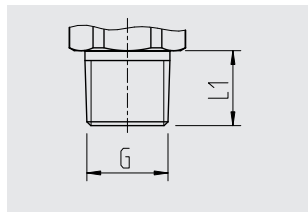

G	L1
¼ NPT	13 (0.51)
½ NPT	19 (0.75)
R ¼	13 (0.51)
PT ¼	13 (0.51)

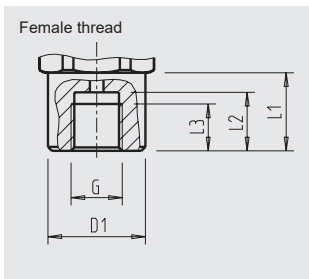

G	L1	L2	L3	D1
G ¼ <sup>1)</sup>	20 (0.79)	15 (0.59)	12 (0.47)	□ 25 (0.98)

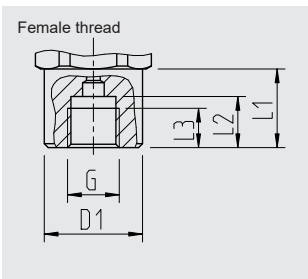

G	L1	L2	L3	D1
G ¼ EN 837	20 (0.79)	13 (0.51)	10 (0.39)	□ 25 (0.98)

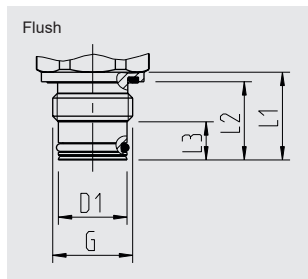

G	L1	L2	L3	D1
G ½ B <sup>2)</sup>	23 (0.91)	20.5 (0.81)	10 (0.39)	□ 18 (0.71)

1) Ermeto compatible

2) Welding sockets recommended as defined counter-thread (see accessories)





